



New Sites Sewage Pump Station Fibre Service Lines Trial Case Study

Sam Khazanchi
Senior Programme Manager
New Sites Customer Experience

19th March 2024 – Version 1.3



DAVID WILSON HOMES

WHERE QUALITY LIVES



BARRATT
HOMES



openreach

Contents

1.0 Executive Summary	3
1.1 Executive Summary Key Notes:	4
2.0 Service Lines Summary	5
3.0 The Sewage Pump Station Fibre Service Lines Trial	6
3.1 Trial Overview, Approach & Objectives	6
3.2 Trial Objectives Summaries & Outcomes	7
3.2.1 Objective 1: Source a suitable cabinet / enclosure that the ONT and associated power source can be fitted within in an external environment.	7
3.2.2 Objective 2: Climate test the ONT in the procured cabinet / enclosure and safety test the cabinet / enclosure.....	8
3.2.3 Objective 3: Identify a Developer to conduct a live trial and provide them with the cabinet / enclosure installation requirements and build plans.....	8
3.2.4 Objective 4: Identify a secure accessible location to house both the Openreach and CP apparatus.	9
3.2.5 Objective 5: Conduct a live trial of connecting a fibre circuit to a SPS.....	9
4.0 Conclusions and Recommendations	12
Appendices 1: Example Openreach ONT Specification	14
Appendices 2: Euro-Craft Technologies Enclosure Specification	18
Appendices 3: Cabinet / Enclosure Openreach Root Installation Drawing.	21
Appendices 4: Cubis SAN-EARTH conductive concrete Installation Method Statement Retrofit.	22

1.0 Executive Summary

Aligned to our strategy to roll out 'Ultrafast Full Fibre' broadband to 25 million homes and businesses by December 2026 and the subsequent switching off of our old copper based network ([click here for more information](#)), the Openreach New Sites organisation published a briefing in November 2021 announcing that from 15th November 2021 any site contracting with us for FTTP will no longer be offered additional Copper for the sole purpose of service lines ([click here to view the briefing](#)). This change is centred on the basis that any new analogue service lines installed today have limited life span requiring migration to All-IP (Fibre) in the future.

Openreach has been working collaboratively with Barratt and David Wilson Homes the UKs largest Housebuilder, and Pump Supplies - one of the UKs leading Sewage Pump Suppliers to conduct the UKs first live publicised trial of connecting a Fibre circuit to serve Sewage Pump Station (SPS) technologies in an external outdoor environment.

The purpose of the trial has been to successfully identify and test a robust solution to connect SPSs with Fibre Service Lines demonstrating Fibre SPS connectivity to replace traditional Copper SPS lines.

This paper has been compiled to encapsulate the details of the SPS trial that successfully concluded on 3rd March 2023 and to share specific technical guidance on connecting SPSs with Openreach Fibre lines.

The objectives of the SPS trial were to:

1. Source a suitable cabinet / enclosure that the ONT and associated power source can be fitted within in an external environment.
2. Climate test the ONT in the procured cabinet / enclosure and safety test the cabinet / enclosure.
3. Identify a Developer to conduct a live trial and provide them with the cabinet / enclosure, installation specifications and build plans.
4. Identify a secure accessible location to house both the Openreach and CP apparatus.
5. Conduct a live trial of connecting a fibre circuit to a SPS.

All the above objectives have been successfully achieved, and the trial therefore deemed a success. Openreach have identified a solution for our ONT to be installed in an external environment using an external cabinet / enclosure that protects our ONT from the outdoor elements and feeds fibre to SPSs. This solution provides the capability to potentially also serve any type of equipment that requires fibre connectivity in an external outdoor environment.

1.1 Executive Summary Key Notes:

- Whilst Openreach have procured and tested a suitable cabinet / enclosure for the trial, Openreach will not provide the cabinet / enclosure. It will be the responsibility of the Developer to procure the Openreach tested cabinet / enclosure directly from the Openreach Vendor, alternatively the Developer can source their own cabinet ensuring that it meets the specification requirements of the Openreach ONTs i.e. maintains correct ambient temperature etc. (see Appendices 1. Example of ONT Specifications).
- The Developer is responsible for installing the cabinet / enclosure in line with Openreach's safety and networking criteria.
- Owing to the dependency of power for both the ONT and CP devices Developers will need to ensure that the external cabinet / enclosure has a power supply and meets our safety requirements.
- This trial has successfully demonstrated that by using a suitable external cabinet / enclosure the Openreach ONT can work appropriately. Although efforts are required by the SPS vendors to ensure that they have suitable solutions in place to support their equipment with fibre digital signalling lines where these are installed.
- Industry have advised that GSM appears to currently be the preferred option, although where a fixed fibre line is required for any new SPSs, vendors will need to ensure that these are digital (and will therefore naturally work with fibre without the need for any signal conversions, as long as they are of a native IP implementation i.e. do not use DTMF signalling tones) or provide a solution for any analogue based equipment.
- Developers continue to have the option of working with vendors to alternatively use GSM type connectivity solutions and we understand from industry that several of these types of alternatives are widely available.

2.0 Service Lines Summary

Some service lines use equipment which still relies on traditional analogue signal and/or the DC voltage carried over the Copper network. Openreach has been engaged with industry over the past few years to ensure that Communication/Service Providers (CPs) and the suppliers in these industries are prepared to move to an All-IP network. There are plenty of support resources for industry available on the Openreach website ([Click here to view these resources](#)).

The Openreach network ends at the Optical Network Termination (ONT), any service line solution that connects to the Openreach network is the responsibility of the CP and the supplier of any equipment to solution. Openreach is unable to provide network solutions beyond our ONT, or to configure any customer equipment, but any CP or industry supplier can reach out to the Openreach All-IP team for support here - All-ip@openreach.co.uk.

Another consideration will need to be local power contingency. Three years ago, OFCOM mandated that any local power backup for special lines should move to the CP to provide. Local power backup means the service line will continue to work, for a period, in the event of a power outage. Traditional Copper networks provide a DC voltage from the exchange which has its own power contingency; hence this has been one of the key industry concerns with moving to an All-IP network. Following the OFCOM decision, Openreach stopped providing Battery Backup Units (BBUs) to all its FTTP installs. It is now down to the CP to provide a local Universal Power Supply (UPS) which will need to provide power contingency for both the CP equipment (router/switch) and the Openreach ONT.

3.0 The Sewage Pump Station Fibre Service Lines Trial

3.1 Trial Overview, Approach & Objectives

A common key requirement for Copper is the Sewage Pump Station Service Line and owing to the national evolution to a full fibre network leading to the subsequent Copper switch off, Openreach New Sites has been faced with the challenge of its current ONT only being certified for internal use and requiring a power source to power the ONT in an external environment.

Subsequently the purpose of the trial has been to identify a workable solution enabling installation of the ONT in an external environment to provide fibre connectivity solutions that replace traditional Copper Sewage Pump Station Service lines.

The objectives of the Sewage Pump Station trial were to:

1. Source a suitable cabinet / enclosure that the ONT and associated power source can be fitted within in an external environment.
2. Climate test the ONT in the procured cabinet / enclosure and safety test the cabinet / enclosure.
3. Identify a Developer to conduct a live trial and provide them with the cabinet / enclosure, installation specifications and build plans.
4. Identify a secure accessible location to house both the Openreach and CP apparatus.
5. Conduct a live trial of connecting a fibre circuit to a SPS.

3.2 Trial Objectives Summaries & Outcomes

This section covers a detailed summary of each of the 5 trial objectives listed in the previous section focusing on what actions were taken and the outcome of each.

3.2.1 Objective 1: Source a suitable cabinet / enclosure that the ONT and associated power source can be fitted within in an external environment.

Several options were reviewed collaboratively by our Chief Engineering and New Sites Teams. It was concluded that whilst any cabinet / enclosure must firstly have the capability to house our ONT and associated power supply safely in an external environment, it must also allow adequate space for the Developer and CP to install their equipment i.e. Router, Analogue Telephone Adaptors, Uninterrupted Power Supply etc.

The final agreed cabinet / enclosure (See Illustration 1) is the product named - 'Cabinet - External Streetside - HP3 & Power Use with Separate Power compartment Door' sourced from Euro-Craft Technologies (See Appendices 2) at a cost of c.£1,000 excluding vat.

Note: the cost includes the cost of the associated base that the cabinet sits on which also needs to be ordered from Euro-Craft. Our ONT was installed in a separate compartment within the cabinet / enclosure to further aid its separation from other vendor equipment (See Illustration 1).

Illustration 1. Euro-Craft External Streetside Cabinet with Openreach ONT fitted.



3.2.2 Objective 2: Climate test the ONT in the procured cabinet / enclosure and safety test the cabinet / enclosure.

The key requirements for the cabinet / enclosure were to ensure that the Openreach ONT can operate successfully and safely within the cabinet / enclosure once it is exposed to the environmental elements.

Our Chief Engineering team installed our ONT within the procured cabinet/enclosure which was then powered and successfully completed testing in our Environmental Testing Chamber.

Testing was based on the specifications of our ONT, testing temperature ranges of -5 and +50 degrees at hourly intervals, the results of which recorded that the internal temperature within the cabinet / enclosure was always within 2 degrees, with no loss of power or impact to the functionality of our ONT when each cycle had been completed.

Note: a powered CP router was also incorporated within this trial as additional devices would have also affected the ambient temperature within the cabinet.

In addition, the cabinet / enclosure has successfully passed safety testing that was led by our Chief Engineering team at our 4 Acres Test Site and is in line with both organisational and regulatory standards.

3.2.3 Objective 3: Identify a Developer to conduct a live trial and provide them with the cabinet / enclosure installation requirements and build plans.

Barratt and David Wilson Homes (BDW) – the UK's largest Housebuilder were secured for this trial, and working alongside Openreach enabled us to successfully produce all our installation specifications and methodology documents required to proceed with installation of the external cabinet / enclosure.

Our initial work surrounded producing the cabinet / enclosure root installation drawings to feed the SPS underground (see Appendices 3: Openreach Enclosure Root Installation Drawing) whilst providing guidance on method statements and utilising the same Cubis SAN-EARTH conductive concrete that Openreach uses for all NGA cabinet installations (see Appendices 4: Cubis SAN-EARTH conductive concrete Installation Method Statement Retrofit).

These documents were finalised and shared with BDW enabling them to proceed with installation of the cabinet / external enclosure.

3.2.4 Objective 4: Identify a secure accessible location to house both the Openreach and CP apparatus.

When considering where to situate the cabinet / enclosure onsite it was agreed that we would install the enclosure behind the SPS to reduce the distance, enabling a shorter underground feed between the two - whilst also ensuring that the Openreach Cabinet / Enclosure resides outside of the secured SPS caged fencing area to provide ease of access for Openreach repair engineers that may need to access the Openreach network in future (see Illustration 2).

Illustration 2. BDW Trial agreed external cabinet / enclosure onsite location.



3.2.5 Objective 5: Conduct a live trial of connecting a fibre circuit to a SPS.

In early 2023 after the cabinet / enclosure had been fully installed, the underground ducts to the SPS completed and the fibre cables pulled through we were able to attend onsite and complete the full end to end installation of the fibre cable to the SPS (see Illustrations 3 and 4).

Note: BDW worked with Pump Supplies to procure and install the Nortech: Envoy EV10 Communications Hub / Intelligent modem within the SPS which was required to ensure that the SPS can send digital signals via the Fibre line (see Illustration 5 and 6).

Illustration 3. SPS Fibre Service Lines Network Map



Illustration 4. SPS Fibre Service Lines Network Map

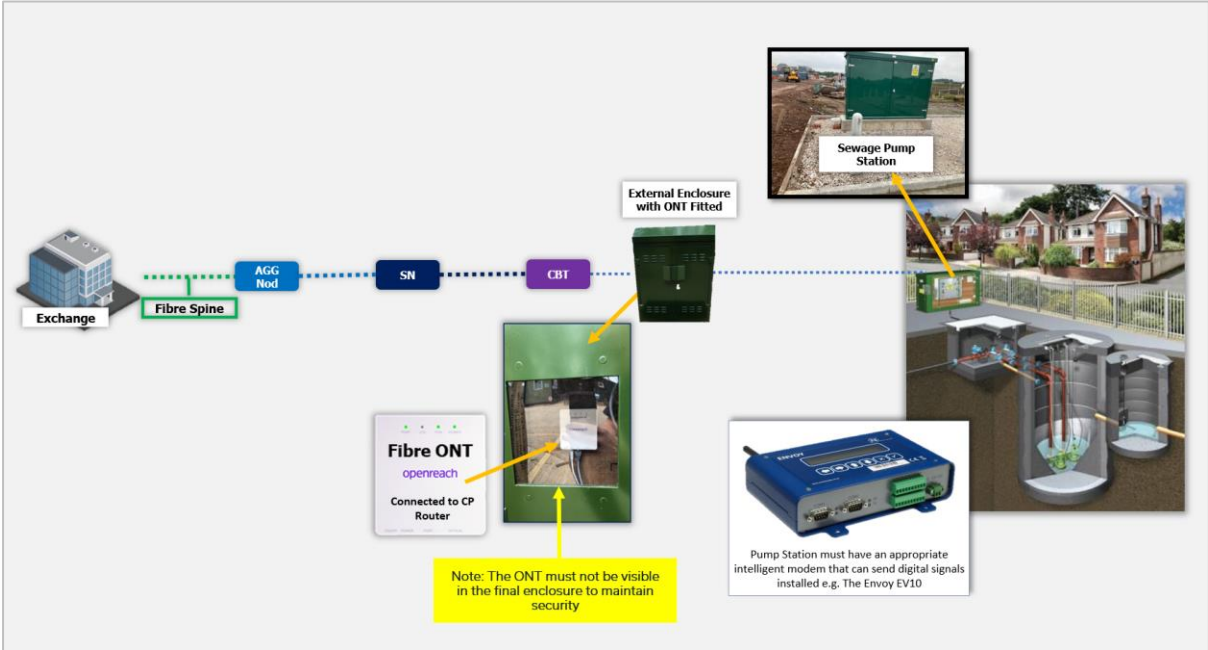

Illustration 5. Nortech: Envoy EV10 Communications Hub / Intelligent modem



Illustration 6. Nortech: Envoy EV10 installed within Sewage Pump Station



Once the installation was completed, Pump Supplies ran a series of simulated SPS failure test scenarios to ensure that the SPS immediately sent digital alerts back to their control centre and several BDW mobile numbers. All tests were concluded successfully verifying that the Fibre Service line was working appropriately with the SPS.

The trial was deemed a success and is now Openreach's standard method of delivering SPS Fibre Service Lines and full guidance can be provided at the point of installation by our Field Based Representatives.

4.0 Conclusions and Recommendations

The purpose of the trial has been to identify a workable solution enabling installation of the ONT in an external environment to provide fibre connectivity solutions that replace traditional Copper Sewage Pump Station lines.

This trial has been deemed a success as it has demonstrated that by using a suitable external cabinet / enclosure the Openreach ONT can work appropriately. Although efforts are required by the Sewage Pump Station vendors to ensure that they have suitable solutions in place to support their equipment with fibre digital signalling lines where these are installed.

To prevent future challenges - for any new Developments where a fixed fibre line will be required, we recommend that Developers ensure that only Digital devices are procured from their vendors as analogue is Copper based and will gradually disappear over the foreseeable future as the country rapidly moves towards a full fibre digital telecommunications infrastructure.

Developers continue to have the option of working with vendors to alternatively use GSM type connectivity solutions and we understand from industry that several of these types of alternatives are widely available.

Another consideration will need to be local power contingency. Three years ago, OFCOM mandated that any local power backup for special lines should move to the CP to provide. Local power backup means the service line will continue to work, for a period of time, in the event of a power outage. Traditional Copper networks provide a DC voltage from the exchange which has its own power contingency; hence this has been one of the key industry concerns with moving to an All-IP network. Following the OFCOM decision, Openreach stopped providing Battery Backup Units (BBUs) to all its FTTP installs. It is now down to the CP to provide a local Universal Power Supply (UPS) which will need to provide power contingency for both the CP equipment (router/switch) and the Openreach ONT.

Whilst Openreach have procured and tested a suitable cabinet / enclosure for the trial, Openreach will not provide the cabinet / enclosure. It will be the responsibility of the Developer to procure the Openreach tested cabinet / enclosure directly from the Openreach Vendor, alternatively the Developer can source their own cabinet ensuring that it meets the specification requirements of the Openreach ONT i.e. maintains correct ambient temperature etc. (see Appendices 1. ONT Specification).

The Developer is responsible for installing the cabinet / enclosure in line with Openreach's safety and networking criteria and owing to the dependency of power for both the ONT and CP devices Developers will need to ensure that the external cabinet / enclosure has a power supply and meets our safety requirements.

The whole electrical installation must be electrical tested to the latest version of BS 7671 and a copy of the EIC certificate left on site or can be requested from the customer. There must be a periodic inspection label and an RCD six-monthly test labels installed and clearly visible in both sections of the cabinet / enclosure (see illustration 7).

Illustration 7. Inspection and RCD test labels

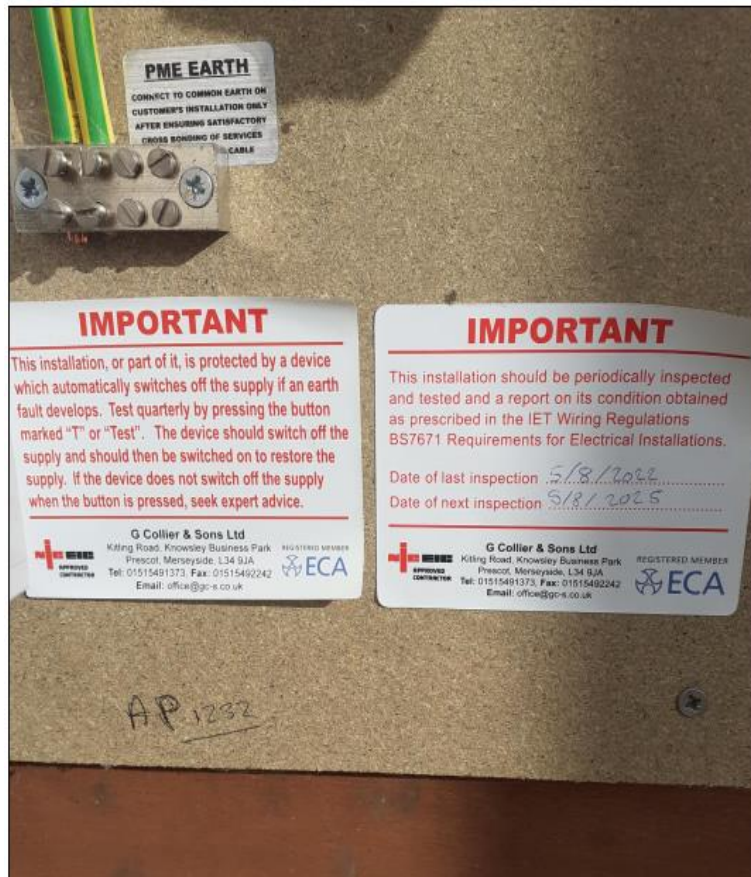

Industry have advised that GSM appears to currently be the preferred option, although where a fixed fibre line is required for any new SPSs, vendors will need to ensure that these are digital (and will therefore naturally work with fibre without the need for any signal conversions, as long as they are of a native IP implementation i.e. do not use DTMF signalling tones) or provide a solution for any analogue based equipment.

Appendices 1: Example Openreach ONT Specification

Quick Start

SDX
611 GPON ONT
SFU, 1GE

November 2020
61287833F20P-13A

P/N: 1287833F20P



Figure 1. SDX 611 GPON SFU ONT, 1GE

DESCRIPTION

The SDX 611 GPON SFU ONT, 1GE (611 GPON ONT) is an Optical Network Unit or Terminal that leverages GPON technology for delivering premium 1 Gbps services.

The 611 GPON ONT is an indoor unit that supports up to 1 Gbps data rates.

Figure 1 illustrates the 611 GPON ONT.

FEATURES

The basic features of the 611 GPON ONT include the following:

- Single GPON fibre interface supporting 1.244 Gbps upstream and 2.488 Gbps downstream
- 1 Gbps Customer Ethernet Interface
- Remote activation and deactivation
- Remote firmware upgrades and downgrades
- Remote OMCI management as per ITU-T G.988

Refer to the following table for a description of each feature in Figure 2.

Callout	Description
1	LEDs
2	GPON fibre interface (Optical SC/APC connector)
3	1 Gbps Ethernet interface (LAN)
4	Power Connection for the Supplied AC to DC Power Converter (12 V)
5	On/Off button

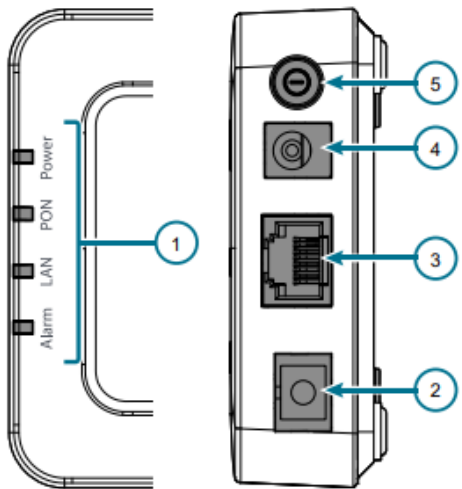



Figure 2. ONT Interfaces



Power

Power is provided by a 12 V DC Power Adapter that is included with the 611 GPON ONT. The power adapter operates from a power source of 100 to 240 V AC, 50 /60 Hz.

INSTALLATION

After unpacking the unit, inspect it for damage. If damage is noted, file a claim with the carrier and then contact Openreach. For more information, refer to the warranty.



CAUTION!

This product is intended for indoor use only. Ethernet cables and attached equipment are intended for use within the same building with equipotential bonding, and not intended to be placed in separate buildings or structures. Failure to deploy as described could result in permanent damage from lightning or other electrical events and voids the warranty.

Installation Guidelines

The following are guidelines for basic installation of the 611 GPON ONT.



WARNING!

Read all warnings and cautions before installing or servicing the 611 GPON ONT.

Installation Overview

To install the 611 GPON ONT, you will need to complete the following steps:

- "Step 1: Install the 611 GPON ONT"
- "Step 2: Connect Ethernet"
- "Step 3: Connect Fibre"
- "Step 4: Connect Power"

Required Tools:

Be sure to route and secure the fibre and cables in a manner that will prevent damage. Standard technician tools and those listed below are required for installing the 611 GPON ONT.

- Personal Protection Equipment (PPE)
- Optical power meter with wavelength filtering
- fiberscope or videoscope
- #2 Phillips-head screw driver
- Drill
- 6 mm (1/4 in) drill bit
- Hammer

For fibre optics connections, the following is required:

- ODC Fiber Cleaning Tool (e.g., 2.5mm CleanClicker, part code 100205 or CleanStixx, part code 100207, with Stickler connector cleaning fluid, part code 105490)

Step 1: Install the 611 GPON ONT

There are two options to install the 611 GPON ONT: Desk Top and Wall Mount. Options are described below.



NOTE

Included with the 611 GPON ONT is a 1.5 m (5 ft) power cord. All installation locations should be within 1.5 m (5 ft) of a wall outlet.

Desk Top Installation

The 611 GPON ONT can be located on a desktop.



CAUTION!

Ensure that the 611 GPON ONT is not located in direct sunlight or next to any thermal obstructions.



WARNING!

Ensure that the 611 GPON ONT does not come in contact with water or other liquids.

Wall Mounting



CAUTION!

Appropriate PPE should be worn before starting installation.

Refer to [Figure 3](#) when installing the 611 GPON ONT on a wall.

1. Decide on a location for the 611 GPON ONT. Mount below eye-level so the LEDs are visible.



NOTE

Supplied hardware is intended for drywall mounting only. For mounting on surfaces other than drywall, obtain the appropriate mounting hardware and follow the provided instructions.

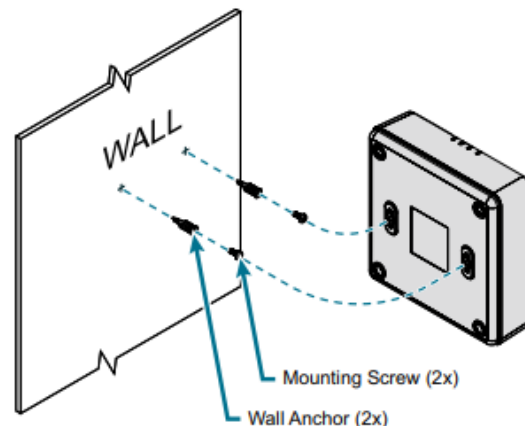

Figure 3. Wall Mount Installation

2. Use the drill template included with the product packaging to drill holes in the wall using a 6 mm (1/4 in) drill bit.
3. Use a hammer to lightly tap the included wall anchors into the drilled holes until anchors are flush with the wall.
4. Install the included screws into the anchor heads. Leave approximately 6 mm protruding from the mounting surface.
5. Slide the 611 GPON ONT over the screws and exert a small amount of downward pressure to ensure that the top of the slots are resting on the shafts of the screws.

Step 2: Connect Ethernet

Refer to [Figure 2](#) on page 1 and insert a Category 5e (or better) Ethernet cable into the port labeled **LAN** until there is an audible "click".

Step 3: Connect Fibre



CAUTION!

To prevent damaging the fibre, do not exceed the fibre bend radius of 8.9 cm (3.5 in).



CAUTION!

LASER RADIATION - 1310 nm to 1600 nm

Do not view directly with optical instruments.

Use of controls, or adjustments, or performance of procedures, other than those specified herein, may result in hazardous radiation exposure.

The fibre cable is installed into the SC/APC connector (**Optical**) located on the rear of the 611 GPON ONT (see [Figure 2](#) on page 1). Complete the following steps to install fibre:

1. Remove the dust cover from the SC/APC Connector and dispose of the dust cover as it could become a choking hazard for small children.
2. Clean the end of the incoming fibre connector and the ONT optical port using an appropriate fibre cleaning tool.
3. Before installing the fibre, use an optical power meter to measure the optical power in dBm power. The level should not exceed -8 dBm. Use an appropriate bi-directional optical attenuator if the power levels are at or above -8 dBm. A level between -12 and -27 dBm is acceptable.
4. Connect the incoming fibre connector.

Step 4: Connect Power



WARNING!

Once installation is complete, please safely remove and dispose of all small items that remain as they could become a choking hazard for small children. This includes the fibre port dust cover, twist tie on power cord, two small screws and wall anchors (if not used) and the plastic bag that holds the screws and anchors.

To connect power to the 611 GPON ONT, complete the following steps:

1. Plug the supplied 12 V AC/DC Power Adapter into the **Power** connection on the rear of the 611 GPON ONT.
2. Connect the Power Adapter to a standard 230 V AC outlet.
3. Press the **ON/OFF** button to turn the 611 GPON ONT on.
4. Verify power is on by checking the **Power** LED on the 611 GPON ONT. The LED should be green, indicating local power is on.



NOTE

Openreach recommends only using the DC power adapter that is provided with the unit.

LEDs

When the 611 GPON ONT first powers up it performs self-tests. Once the power up self-tests are complete, the status LEDs will reflect the state of the hardware. The table below details the status indicated by the LEDs.

LED	Status	Indication
Power	○ Off	Power is off
	● Green	Power is on, self-test passed, normal operation
	* Green Flashing	Unit is powering up
PON	● Green	ONU ranged, authenticated, and configured with Data, Video, Voice, or Subtended Host services
	* Green Flashing (Fast)	ONU is ranging and synchronisation process in progress*
	* Green Flashing (Slow)	ONU ranged and authenticated but not configured with any services
	● Red	PON is down due to LOF/LOS condition, or not activated by OLT
LAN	○ Off	No Ethernet connectivity
	● Green	Ethernet connectivity present, no activity
	* Green Flashing	Ethernet connectivity present, activity detected Interface operation state is up and packets Tx/Rx detected on the interface
Alarm/Update	○ Off	No alarm detected
	● Green	ONU software download complete and software upgrade in progress. LED will turn off once upgrade is successful
	* Green Flashing	ONU software download in progress
	● Red	ONU is powered up and PON operational state is up and ONU software upgrade failed New ONU software not operational due to any of the following reasons: <ul style="list-style-type: none"> ■ Software image download failed ■ Software image flash write failed ■ Software image activation failed ■ Software image commit failed

* This process is normally very quick; you will only see this condition if a ranging and synchronisation process is having difficulty in completing at OLT.

openreach

SPECIFICATIONS

Specifications for the 611 GPON ONT are as follows:

- Electrical
 - ◆ Input: 12 V DC, 0.5 A
 - ◆ Maximum Power Consumption: 6 W
 - ◆ Power Supply Adapter: 12 V DC Power Adapter
 - Input Voltage Rating: 100 - 240 V AC, 50/60 Hz
 - Output Voltage Rating: 12 V DC
 - Output Current Rating: 0.5 A
- Optical
 - ◆ TX min power: +0.5 dBm
 - ◆ TX max power: +5.0 dBm
 - ◆ RSSI max sensitivity: -27.0 dBm
 - ◆ RX overload: -8.0 dBm
 - ◆ TX wavelength: 1310 nm typical
 - ◆ RX wavelength: 1490 nm typical
- Physical
 - ◆ Height: 2.40 cm (0.95 in)
 - ◆ Width: 8.00 cm (3.15 in)
 - ◆ Depth: 8.00 cm (3.15 in)
 - ◆ Weight: 0.09 kg (0.20 lbs)
- Environmental
 - ◆ Rated Operational Temperature Range: 0°C to +40°C
 - ◆ Storage Temperature Range: -40°C to +70°C
 - ◆ Relative Humidity: up to 95%, noncondensing

MAINTENANCE

The 611 GPON ONT does not require routine hardware maintenance for normal operation. This device is the property of Openreach LTD and must only be repaired or removed with Openreach consent.

Openreach does not recommend that repairs be attempted in the field. Repair services may be obtained by returning the defective unit to Openreach. Refer to the warranty for further information. Field support for software is provided through upgrade facilities.

SAFETY AND REGULATORY

Refer to the Safety and Regulatory Notice for this product (P/N: 61287833F2OP-17A) for detailed safety and regulatory information.

For more safety and regulatory information, refer to openreach.co.uk/productuserguides.

ADTRAN Inc. is the IPR owner of this device.
This device is the property of Openreach LTD and must only be repaired or removed with Openreach consent.

Openreach LTD
123 Judd Street
London
WC1H9NP



Copyright © 2020 ADTRAN, Inc. All Rights Reserved.

Appendices 2: Euro-Craft Technologies Enclosure Specification

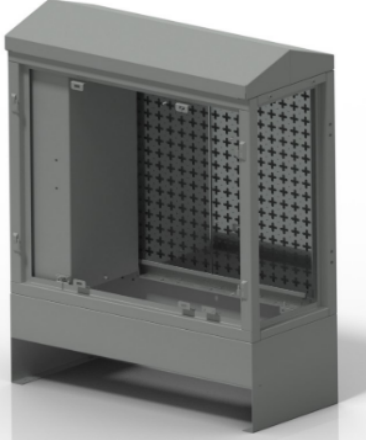

Product Name:	Cabinet - External Streetside - HP3 & Power Use With Separate Power compartment Door																			
	For Use On	SKU																		
		ETL Ref																		
		26944090/101 26944090/102																		
																				
<p>Product Specification:</p> <p>Cabinet Size - 900x940x400/415mm WHD Nominal weight 120Kg</p> <p>Material: - 2mm stainless steel</p> <p>Finish: - Grey textured paint</p> <p>Cable - Earth cables compliant to EN-50575:2014/A1:2016 Reaction to fire class - Eca</p>	<p>Kit Contents:</p> <p>Vented RH and LH hinged lift off door with 2060 (14mm) lock to RH door and louvre baffles.</p> <p>10009512 – LH Vented Side power compartment door ***** – RH Vented Side power compartment door Both options have lift off door and meter viewing window. 2060(14mm) lock fitted and louvre baffles</p> <p>2off Star cross punched backboards Wooden backboard to power compartment</p> <p>M8 cabinet to root bolting down kit including panel seal</p>																			
<p>Notes:</p> <p>Root not included - see SKU 10009514 for root, For URBA see 10009515 High pitched Roof options see 10011687, 10011688</p>																				
<table border="1" style="width: 100%; border-collapse: collapse;"> <thead> <tr> <th style="text-align: left;">Replacement panel-work</th> <th style="text-align: left;">Replacement accessories</th> </tr> </thead> <tbody> <tr> <td>***** -Roof kit, ETL ref 26944012/930</td> <td>***** -Main door close rod, ETL ref CA2500410002</td> </tr> <tr> <td>***** -LH Frt door, ETL ref 26944012/940</td> <td>***** - Main door close rod, ETL ref CA2500410008</td> </tr> <tr> <td>***** -RH Frt door, ETL ref 26944012/942</td> <td>***** -LH HINGE, ETL ref 26000000/903</td> </tr> <tr> <td>***** -Side panel, ETL ref 26944012/952</td> <td>***** -RH HINGE, ETL ref 26000000/904</td> </tr> <tr> <td>***** -LH Side door, ETL ref 26944012/950</td> <td>10006295 -14mm LOCK, ETL ref CA2600030000</td> </tr> <tr> <td>***** -RH Side door, ETL ref 26944012/951</td> <td>67610383 -ROD ADAPTOR, ETL ref CA2600060000</td> </tr> <tr> <td>***** -Backboard, ETL ref 26944012/960</td> <td>10007475 -DOOR GASKET, ETL ref 35000000/021</td> </tr> <tr> <td></td> <td>***** - DOOR STAY BAR, ETL ref 26000000/911</td> </tr> </tbody> </table>	Replacement panel-work	Replacement accessories	***** -Roof kit, ETL ref 26944012/930	***** -Main door close rod, ETL ref CA2500410002	***** -LH Frt door, ETL ref 26944012/940	***** - Main door close rod, ETL ref CA2500410008	***** -RH Frt door, ETL ref 26944012/942	***** -LH HINGE, ETL ref 26000000/903	***** -Side panel, ETL ref 26944012/952	***** -RH HINGE, ETL ref 26000000/904	***** -LH Side door, ETL ref 26944012/950	10006295 -14mm LOCK, ETL ref CA2600030000	***** -RH Side door, ETL ref 26944012/951	67610383 -ROD ADAPTOR, ETL ref CA2600060000	***** -Backboard, ETL ref 26944012/960	10007475 -DOOR GASKET, ETL ref 35000000/021		***** - DOOR STAY BAR, ETL ref 26000000/911	<p style="text-align: center;">For other metalwork/accessories please email sale@eurocraft.co.uk or call 01385 215000</p>	
Replacement panel-work	Replacement accessories																			
***** -Roof kit, ETL ref 26944012/930	***** -Main door close rod, ETL ref CA2500410002																			
***** -LH Frt door, ETL ref 26944012/940	***** - Main door close rod, ETL ref CA2500410008																			
***** -RH Frt door, ETL ref 26944012/942	***** -LH HINGE, ETL ref 26000000/903																			
***** -Side panel, ETL ref 26944012/952	***** -RH HINGE, ETL ref 26000000/904																			
***** -LH Side door, ETL ref 26944012/950	10006295 -14mm LOCK, ETL ref CA2600030000																			
***** -RH Side door, ETL ref 26944012/951	67610383 -ROD ADAPTOR, ETL ref CA2600060000																			
***** -Backboard, ETL ref 26944012/960	10007475 -DOOR GASKET, ETL ref 35000000/021																			
	***** - DOOR STAY BAR, ETL ref 26000000/911																			

Doc reference 10009512
Issue A - 13.07.18

^ v 1 of 1 + ↺ +

HP3 POWER CAB
TYPICAL EXTERNAL
& INTERNAL
DIMENSIONS

WOODEN
BACKBOARD
FOR LEC
CUT-OUT
& METER

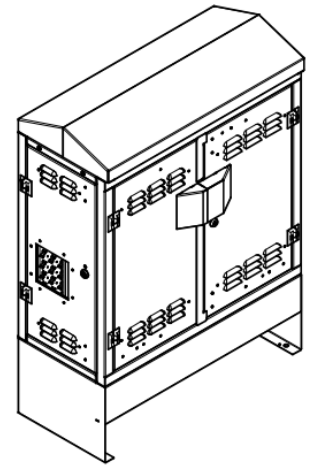
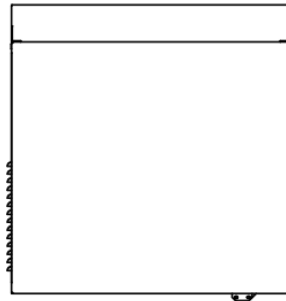
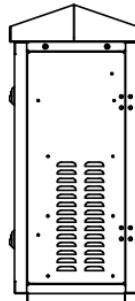
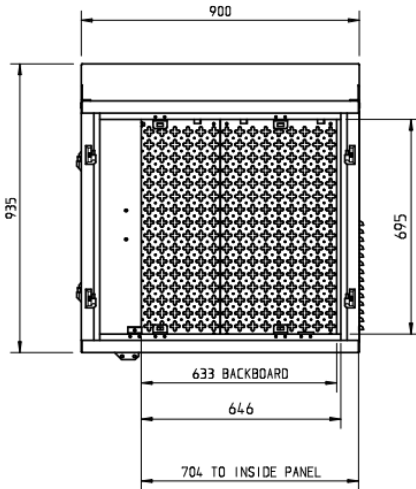
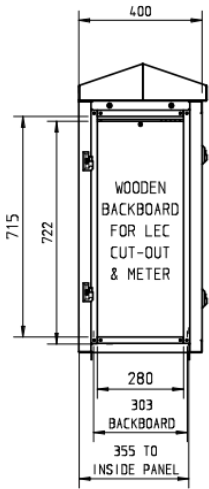
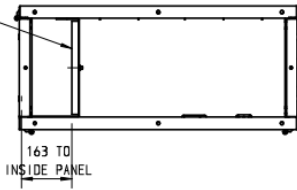

openreach

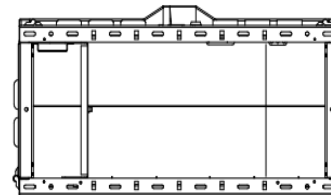
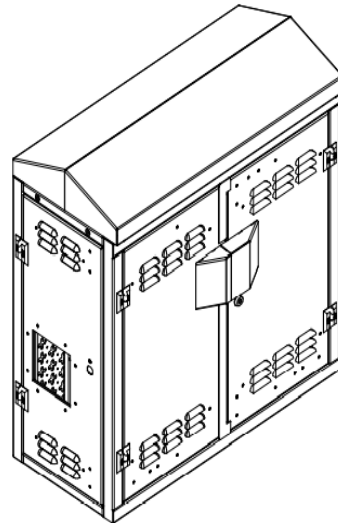
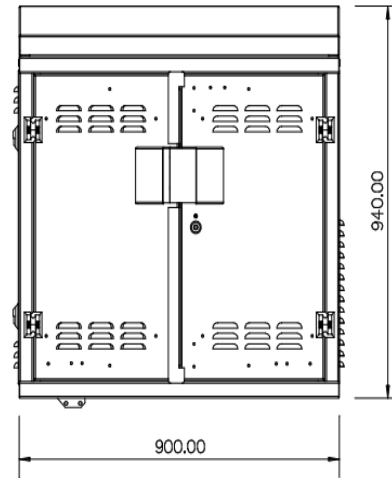
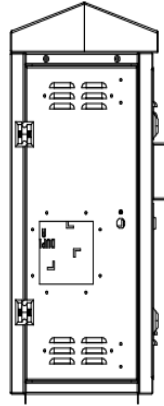

Appendices 3: Cabinet / Enclosure Openreach Root Installation Drawing.

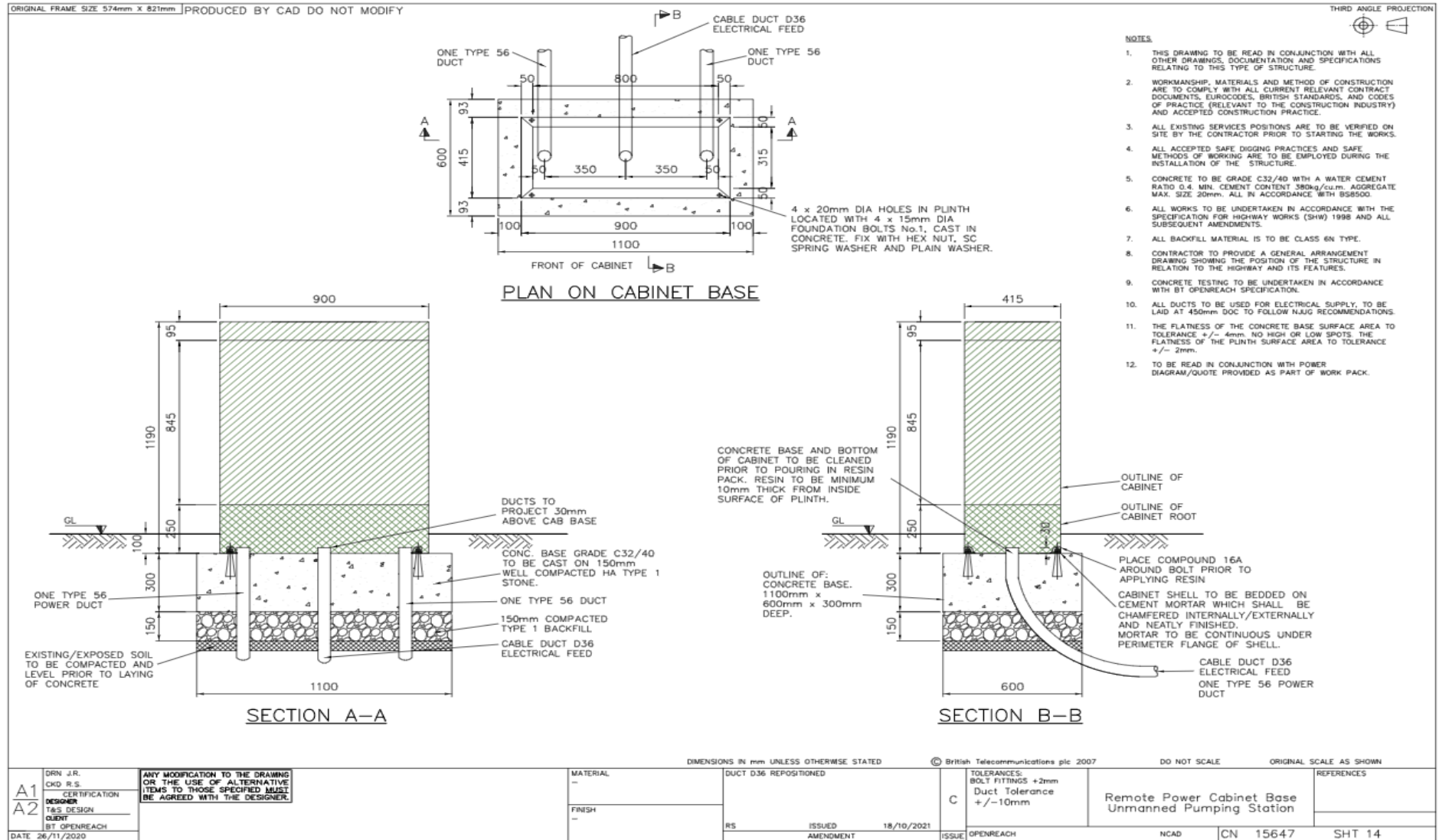

Appendices 4: Cubis SAN-EARTH conductive concrete Installation Method Statement Retrofit.



Cubis San-Earth Conductive Concrete
Installation Method Statement Retro Fit

openreach

www.cubis-systems.com
+44 (0)28 38 313 100
techsupport@cubis-systems.com

V3.8 26/08/2020

METHOD STATEMENT FOR THE RETROSPECTIVE INSTALLATION OF CUBIS SAN EARTH

SCOPE

This method statement covers the retrospective installation of Cubis SAN-EARTH conductive concrete for Openreach NGA cabinets. The Cubis SAN-EARTH installation process for new build remains the same and is covered in ISIS EPT/ANS/A055.

This document is for information and guidance only.

HEALTH AND SAFETY

Anyone entering the cabinets must use a non-contact volt stick and proving tool (OR item code 093746) to confirm that the cabinet shell is not live before opening.

Care should be taken to avoid physical contact with this product. Prolonged or repeated skin contact may cause irritation. Allergic dermatitis may develop in hypersensitive individuals. The combination of conductive concrete powder and sweat on the skin may be sufficient to cause burns.

It is recommended that washing facilities be nearby when Cubis SAN-EARTH is installed. Wash hands frequently when exposed to dust and wash thoroughly after each installation is complete. Wash thoroughly before eating or other hand to mouth contact.

Avoid breathing the dusts. A dust respirator should be used. Adequate exhaust ventilation should be provided when the product is installed in a confined space. Direct eye contact with this product may cause injuries. Rinse immediately if contact occurs.

Further information is available through the Cubis SAN-EARTH Material Safety Data sheet (MSDS) which can be found by visiting: www.conductive-concrete.com

RISK ASSESSMENT

It is the responsibility of the contractor to carry-out risk assessments to ensure that HSG47 (Avoiding danger from underground services) recommendations/best practices are not breached related to use of concrete-based material in close proximity to other buried underground services. If a risk assessment indicates that the HSG47 recommendations will not be met, the contractor should seek further guidance through the Principal Contractor Health and Safety Team before proceeding with the installation. Under no circumstance can the earth electrode be connected or touching any other services buried within the ground.

PERSONAL PROTECTIVE EQUIPMENT

EYES:	Chemical goggles EN 166B
SKIN:	Rubber gloves BS EN 388 disposable over sleeves, disposable over shoes & disposable over leggings all in compliance with (PPE Directive 89/686/EEC).
RESPIRATORY:	Wear a FFP3 approved dust respirator
RISK PHASES:	R20, R21, R22, R36, R37, R37, R38 & R66 (See appendix 2 for further details on risk phase considerations)

MATERIAL REQUIREMENTS

In order to complete the attached method statement you will require the materials listed below. The majority of installations will require only a primary earth pit, however where the resultant Ra reading is above 150 Ohms for a TTS System, a secondary earth pit will be required. See Appendix 3 for the recruitments for a TNCS system.

Kit Code	Material	Excavation Type		Total Materials
		Primary Earth Pit	Secondary Earth Pit	
See Appendix 4 for ordering instructions	Cubis SAN-EARTH Conductive Concrete	4 Bags	4 Bags	8 Bags
	Cubis SAN-EARTH XLR8 Accelerator	4 Litres	4 Litres	8 Litres
	Cable Assembly (including 2 x Labels)	Retro S	Retro S	2 x Retro S
	Detectable Tape (provided in 25mtr rolls)	As Required	As Required	As Required
Contractor Supplied	Water - added to obtain a slightly sloppy mixture	38 Litres	38 Litres	76 Litres

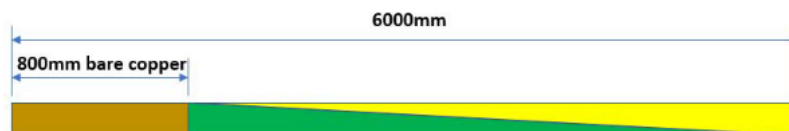

Electrode required for retro fitting conductive concrete - overall length of 6 meters with 800mm bare/exposed copper at one end.

The use of a 60 litre reusable tub (Contractor to supply), 1300w drill & a 140mm diameter paddle as a minimum is recommended.

Failure to use all the approved Cubis materials listed above will invalidate the 25 year design life.

/01

ADDITIONAL INFORMATION

This method statement is to be used for retrofitting Conductive Concrete and NOT installing a new build DSLAM. Please refer to the separate New Build Method Statement and supporting video (www.conductive-concrete.com).

1. Keep the bags of Cubis SAN-EARTH conductive concrete, cable assembly and XLR8 protected from moisture (i.e rain etc.) until ready to deploy. PPE should be worn for the duration of the installation.
2. Measure out and mark the location of the primary excavation to match the location and dimensions highlighted on the job cover sheet. (Ref: Appendix 1 which show standard construction for both left and right hand configuration options).
3. Excavate a trench from the earthpit to the cabinet. Ensure to retain some of this material for back fill.
4. The earth pit can now be excavated. All spoil from the dig is to be removed from the job site. Final dimensions of the earth pit should be 900mm long at the top, 700mm long at the bottom, 200mm in width and 500mm deep. The top of the earth pit should be a minimum of 250mm from the top surface before final reinstatement giving an overall depth of 750mm. (Ref: Appendix 1).

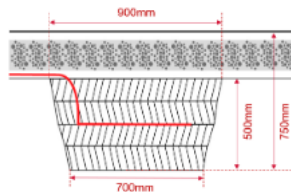

5. Remove any loose material from the bottom of the excavation.
6. Measure and cut one length of duct 36 / duct 56 as appropriate to suit the trench excavation between the earth pit and the cabinet. Once the Duct is in situ, place the sand over the duct and then place the Openreach detectable tape over the duct (as per NJUG Guidelines) ensuring there is sufficient detectable tape to cover to the earth pit when finished.
7. Remove the RetroS cable assembly from its bag and feed it through the newly installed duct back to the cabinet. (Ref: Appendix 1 for cable assembly configurations). Note this can be either on the left or right hand side of the cabinet.



Take photo of excavation at this point as per Fig.1 & 2. (For Internal audit purposes)



Fig. 1



Fig. 2

8. Before the mixing process begins, PPE SHOULD BE APPLIED AND WORN AT ALL TIMES. Take two bags of Cubis SAN-EARTH powder and a suitable sized mixing tub capable of holding 60lts of mixed material. Position the tub close to the earth pit, plastic must be laid down on the ground and the mixing container placed on it to stop contamination of the ground. Fill the tub with 14lts of clean water and 2 litres, 1 container of XLR8, you can add up to an additional 5 litres (maximum) of water to obtain a sloppy mixture Then carefully open the top of the SAN-EARTH bags at the filler spout and slowly pour the contents of the two bags into the water. At the same time as pouring the bags into the water another operative should be mixing the material with a slow action drill and paddle, mixing the material into a mortar. We recommend the use of a 1300w drill and a 140mm diameter paddle mixer to ensure a consistent mix, do not use a shovel to mix.
In wet or windy conditions the use of a suitable tent and ground cover should be considered.
9. Slowly shovel the mortar into the excavation. Care should be taken that the mortar does not splash.

/02

RETROSPECTIVE INSTALLATION - METHOD STATEMENT

10. Carefully lay electrode on top of the conductive concrete, ensuring the electrode remains in place and **DOES NOT TOUCH SURROUNDING EARTH**. Failure to do so will result in earthing issues and incorrect earth readings.

Take photo of excavation at this point as per Fig 3. (For Internal audit purposes)



Fig. 3a



Fig. 3b

Repeat step 8 using the remaining two bags of Cubis SAN-EARTH. A total of four bags of Cubis SAN-EARTH and four litres of XLR8 will be required per earth pit.

11. Ensure the insulated part of the earth electrode is inserted into the Conductive Concrete, ensuring no bare copper is exposed at the top of the earthpit.

Take photo of excavation at this point as per Fig. 4 & 5. (For Internal audit purposes)



Fig. 4



Fig. 5

12. Now carefully place 100mm of as dug material on top of the San-Earth (ensuring it is free from any large stones or lumps etc.). Then place the Openreach detectable tape on top of the as dug material. Leave the San-Earth to set (up to 2 hours), during this time a qualified, trained and competent electrician can test the earth electrode (Ra reading) and complete the electrical installation certificate.

If the reading measures more than 150 Ohms for a TTS system, for a TNCS system please see Appendix 3, you are required to excavate a secondary earth pit and install an additional earthing electrode. (In line with drawing BT100 - exclusion zones)

- 12a. If the site requires the installation of a secondary electrode (a second conductive concrete will be required, see Appendix 4), please repeat steps 2 - 12 using an appropriate cable assembly. *If access is limited on one side of the cabinet, ensure all same-side excavation is at least 1.5 meters from the primary earth pit. (Ref: Appendix 1 which show standard construction for both left and right hand configuration options).

13. The cable from the second (or multiple) pit needs to come directly back to the cabinet, trimmed and terminated as per first cable (it is important that there are no external connections outside of the Cabinet i.e. no daisy chaining of the earth pits).



The two (or more) earth cables need to be connected to a ring eyelet crimp terminal and then tested (**Ra to be recorded and photographed as per Fig. 6**) prior to making the final connection to main earthing terminal within the cabinet.

14. Cut the old, disconnected earth cable to ensure no exposed copper, tape the end. The "Do Not Re-Attach" yellow label goes on the old disconnected earth system. The "Safety Electrical Connection" white label goes on the new San-Earth conductive cable. Proceed to connect the new San-Earth Electrode prior to disconnecting the old system.

15. Take a photo of the final connection of the electrode on the main earth terminal, clearly showing the white label attached. Also photo the disconnected earth electrode showing the correctly attached yellow label Fig. 7.



Fig. 7



Fig. 6

16. Remove the empty bags after use as per regulations for bags of ordinary cement.

17. The pavement can be reinstated same-day, after a MINIMUM CURING PERIOD OF 2 HOURS: (ensure firm) once the Cubis SAN-Earth has set, leaving the site clean and tidy, removing any left over materials.

18. Any duct where the seal has been removed to gain access for the new earth electrode must be resealed. The resealing kit item code is 089825 (Resin pack 14C).

19. Ensure that the A55 earthing electrode document (Earth Certificate) is completed, showing the location, length and direction of the copper tail and whether both tails have been used. Ensure the location of duct is noted. Please also ensure label provided is placed on the insulated earth cable. Complete an Electrical Installation Cert., leaving a copy in the Cabinet and also upload a copy to the relevant database.

Further information can be found by visiting: www.conductive-concrete.com

/03

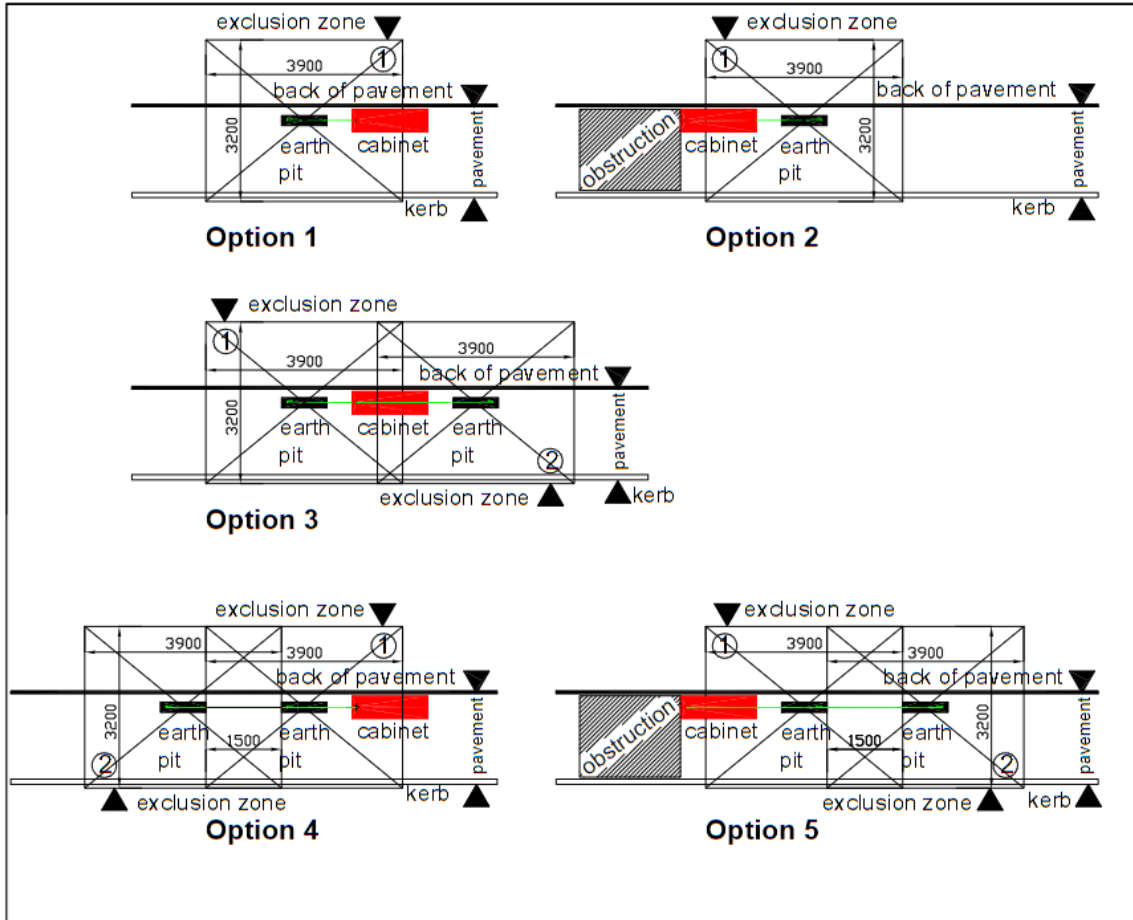

NOTES

1. This drawing has been produced by GROUNDED EARTH LTD.
2. The earthing shown on this drawing has been designed by SANKOSHA U.S.A., Inc.
3. This drawing is to be read in conjunction BT cabinet drgs
4. All dimensions shown on this drawing are in millimetres.
5. Do not scale this drawing.



**RETROFIT ELECTRICAL EARTHING for BT OPENREACH
TYPICAL LAYOUT OPTIONS IN PAVEMENTS
FOR TYPICAL CABINET INSTALLATIONS**

ISSUE	A MENDMENTS	APP'D	DATE
DRAWN: GCM	CHECKED:		SCALE:
DATE: 21-01-19	DATE:		NTS
DRG. NO. BT-100			SHT. NO. 1 of 1

openreach

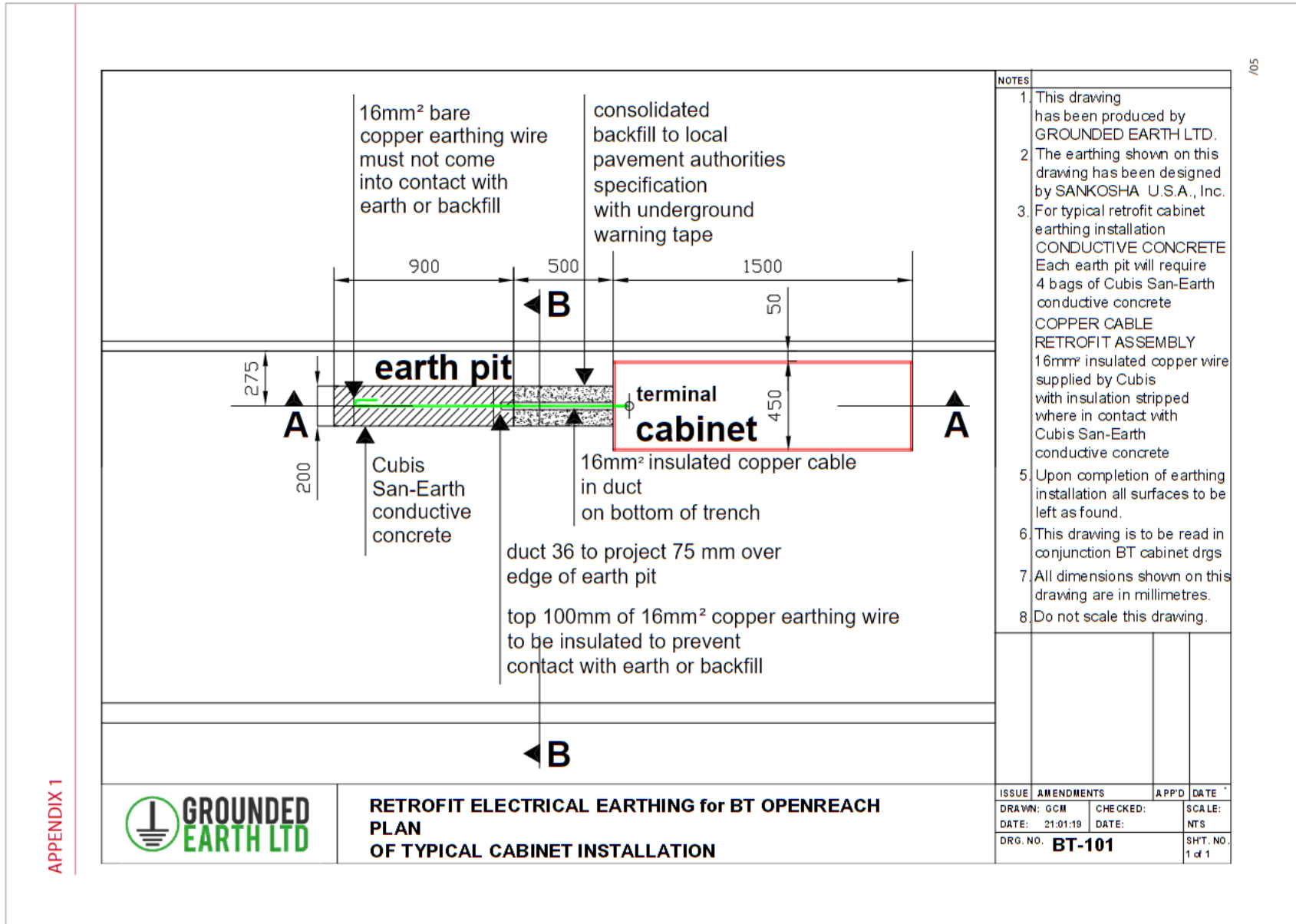

705

openreach

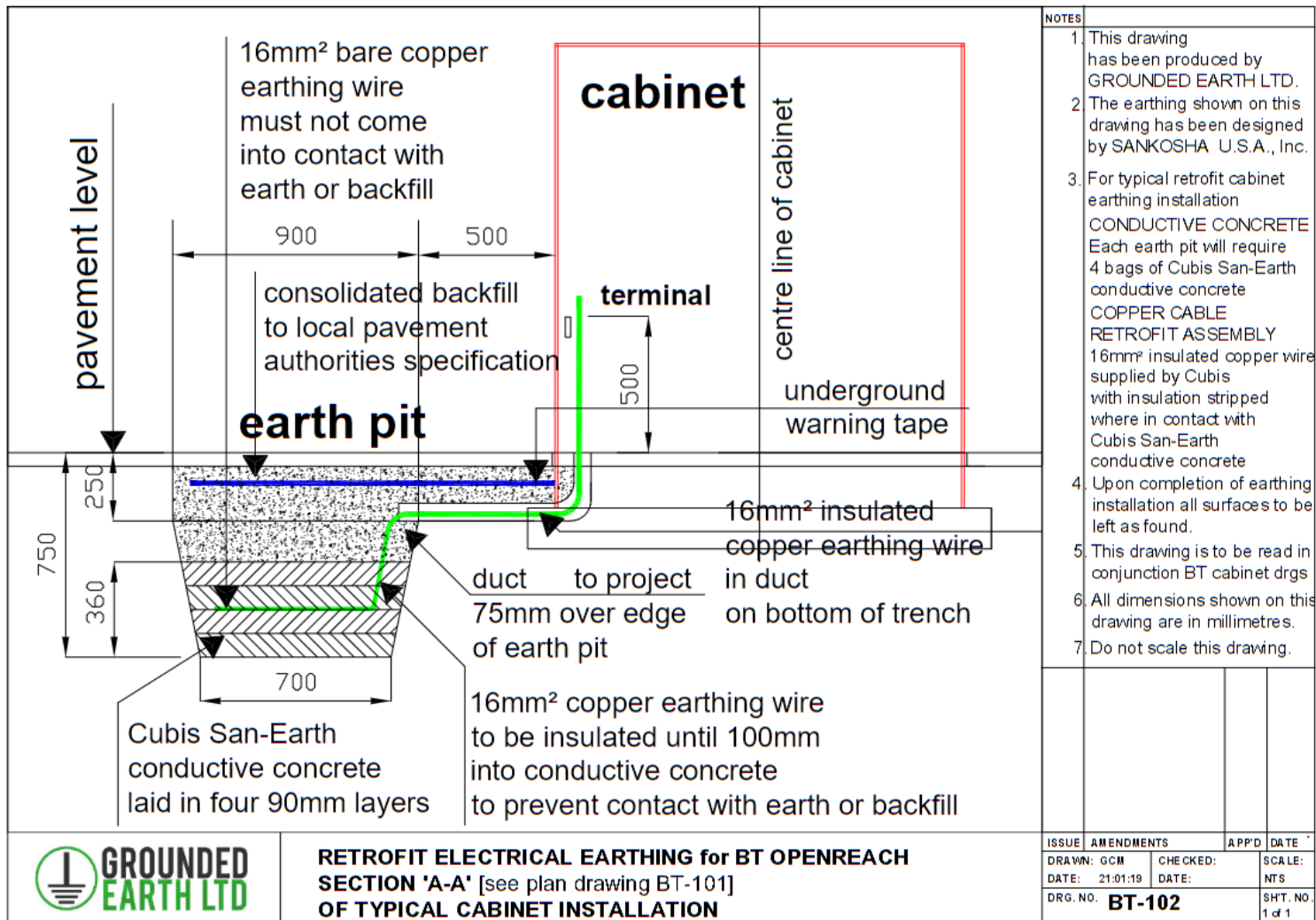

APPENDIX 1



RETROFIT ELECTRICAL EARTHING for BT OPENREACH
SECTION 'A-A' [see plan drawing BT-101]
OF TYPICAL CABINET INSTALLATION

/06

openreach

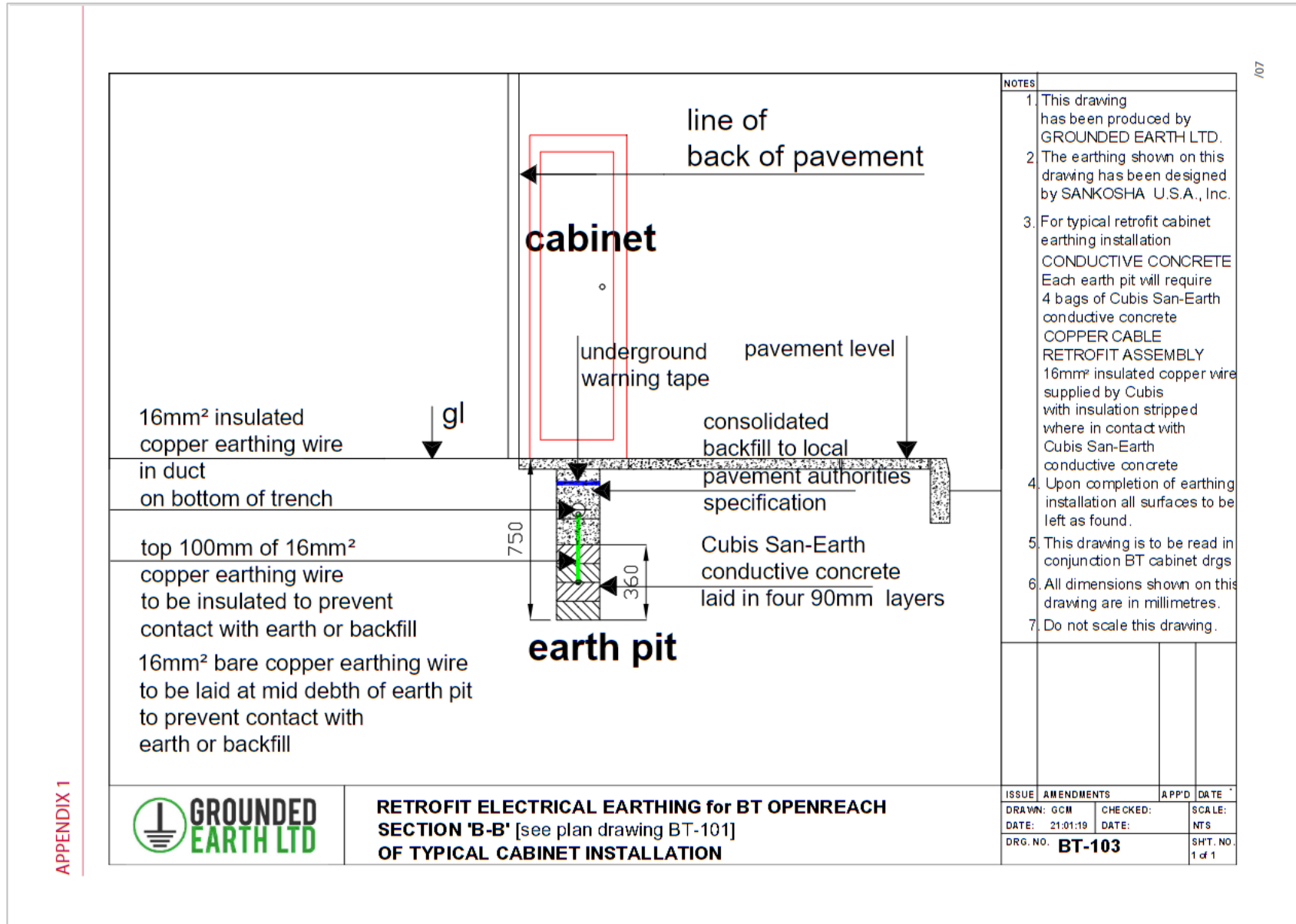

- NOTES
1. This drawing has been produced by GROUNDED EARTH LTD.
 2. The earthing shown on this drawing has been designed by SANKOSHA U.S.A., Inc.
 3. For typical retrofit cabinet earthing installation CONDUCTIVE CONCRETE RETROFIT ASSEMBLY 16mm² insulated copper wire supplied by Cubis with insulation stripped where in contact with Cubis San-Earth conductive concrete
 4. Upon completion of earthing installation all surfaces to be left as found.
 5. This drawing is to be read in conjunction BT cabinet drgs
 6. All dimensions shown on this drawing are in millimetres.
 7. Do not scale this drawing.

APPENDIX 1



RETROFIT ELECTRICAL EARTHING for BT OPENREACH SECTION 'B-B' [see plan drawing BT-101] OF TYPICAL CABINET INSTALLATION

ISSUE	AMENDMENTS	APP'D	DATE
DRAWN: GCM	CHECKED:		SCALE: NTS
DATE: 21.01.19	DATE:		
DRG. NO. BT-103			SHT. NO. 1 of 1

/07

APPENDIX 2

RISK PHASES

Risk Phase Reference	Description
R20	Harmful Inhalation
R21	Harmful in contact with skin
R22	Harmful if swallowed
R36	Irritating to eyes
R37	Irritating to respiratory
R38	Irritating to skin
R66	Repeated exposure may cause skin dryness or cracking

APPENDIX 3

For a TNCS system please use these figures in the table below:

Maximum Load	Maximum Consumer Earth Electrode Resistance Bonded to Main Earth Terminal
≤ 500W	100 Ω
≤ 1kW	60 Ω
≤ 2kW	20 Ω

Note: When calculating the Maximum Load of the installation use the maximum load of the DSLAM cabinet add the load of the PCP side pod and or AC forwarding DSLAM load (if installed). Please refer to ISIS EPT/ANS/A055 Table 6.1 & Table 6.2 .

HOW TO IDENTIFY THE CORRECT EARTHING SYSTEM



TT System with RCD



TNCS System with no RCD

APPENDIX 4 - ORDERING

To order materials, please contact Cubis Systems on +44 (0)28 38 313100 or sales@cubis-systems.com.

Kit Code	Material	Total Materials
ACCKKIT-1	Cubis SAN-EARTH Conductive Concrete (25kg)	36 Bags
	Cubis SAN-EARTH XLR8 Accelerator (2lt container)	18 Containers (36 Litres)
	Cable Assembly (including 2 x Labels)	9 Cable Assemblies
	Detectable Tape (provided in 25mtr rolls)	1 Roll
	Yellow - "DO Not Reconnect" labels	9 Labels
	White - "Safety Electrical Connection" labels	9 Labels